



JRFS-XXXY SERIES

ULTRA FLEXIBLE ROGOWSKI COIL CURRENT TRANSFORMER



The flexible Rogowski coil of high-accuracy split-core current transformers offer significant installation advantages over the general split-core CT's because of their light weight, wide current range (10 - 3000 Amps), mechanical flexibility for mounting in tight quarters and easy placement around cable bundles or large busbars.

Offered in 1.38", 2.16", 3.15" and 4.13" window sizes, the JRFS-Y series are the most accurate Rogowski Coil in submetering. The JRFS-Y series are certified by UL 2808 Listed (XOBA) to meet the new regulation about Power monitoring equipment that may be used in accordance with NEC 312.8(B).

These new Revenue-Grade flexible Rogowski coil CT complying IEEE/ANSI C57.13 class 0.6 accuracy standard may be used with remotely mounted devices certified as Energy Usage Monitoring Systems (FTRZ) by UL.

Features

- Quick & simple install with plug & clasp locking
- Safe 120 mV secondary output (60Hz)
- Current range: 10 - 3000 Amps
- Accuracy standard: IEEE/ANSI C57.13 class 1.2
- UL / EN 61010-1 & UL 2808 Listed (XOBA, XOBA7)

Model	Rated Amps	Output	Frequency	Accuracy
JRFS-035Y	500 A	60 mVac	60 Hz	1.0
JRFS-055Y	1000 A	120 mVac	60 Hz	1.0
JRFS-080Y	2000 A	240 mVac	60 Hz	1.0
JRFS-105Y	3000 A	360 mVac	60 Hz	1.0

How to Use

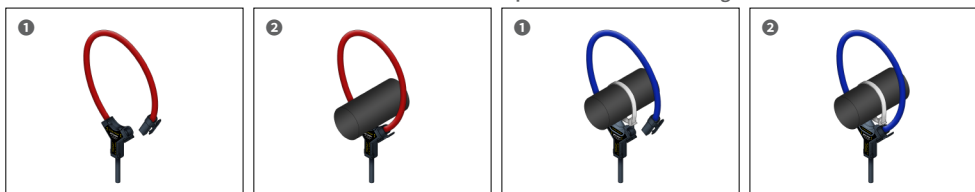

Please refer to "Rogowski coil Current Transformer Installation Guide" for further details.

1. Specifications

- **Coil length** : 18 cm - 30 cm
- **Window size** : 35 mm - 105 mm
- **Cord diameter** : 7 ±0.2 mm
- **Weight** : 100 - 200 g

- **Output level (RMS) :** 100 mV / kA @ 50 Hz, 120 mV / kA @ 60 Hz
- **Max measurable current :** 3 kA @ 50/60 Hz with 18 - 30 cm coil length
- **Coil resistance :** 30 - 120 Ohms
- **Positioning error :** One loop → < 1.0% of reading
Two loop → < 0.5% of reading
- **Frequency :** 40 Hz - 5 kHz
- **Overvoltage category :** CAT IV 600 Vrms, Service Entrance
- **Pollution degree :** 2, Controlled Environment
- **Insulation test voltage :** 7400 Vrms / 1 min
- **Connection cable :** 2 x AWG18 shielded, double insulated, standard length 1.5 m (option 2 m - 15 m)
- **Protection degree :** IP20 (Option: IP65)
- **Altitude :** up to 2000 m over sea-level
- **Operating temperature :** -40 °C - +75 °C for coil with 2 kA max measurable current
-40 °C - +60 °C for coil with 3 kA max measurable current
- **Storage temperature :** -40 °C - +90 °C
- **Relative humidity tolerance :** 0 - 95%
- **Installation and use :** Controlled environment, Indoor
- **IEC, UL standards :** IEC 61010-1, IEC 61010-2-032, UL 61010-1, UL 2808

2. Output Accuracy

- **Ratio Error :**
Accuracy 1% conforms to IEC 61869-2 & IEEE/ANSI C57.13 meets the measuring range from 5% to 120% of I_n
- **Phase Angle :**
50/60 Hz - 0.0 to 1.0 degrees leading from 5% to 120% of rated current

3. Dimensions

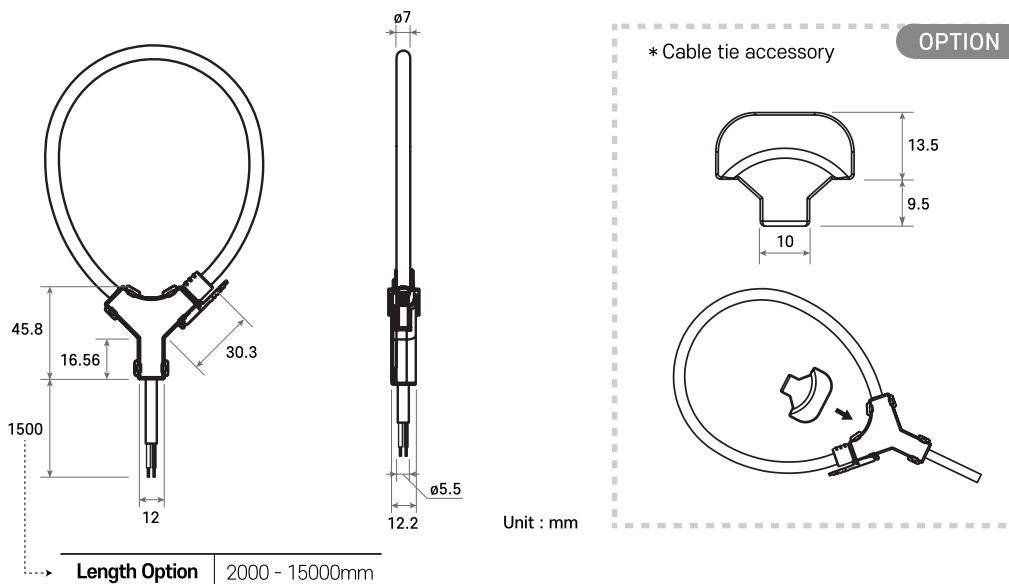

Connection

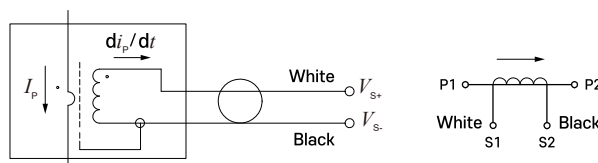

4. Typical Accuracy

- In the following graphs, a positive phase angle error indicates that the output of the Rogowski coil CT with RM type integrator leads the primary current.
- Graphs show typical performance at 25°C, 60 Hz
- Performance Graphs - The standard CT meets IEEE C57.13 class 1.2 standard & IEC 61869-2 class 1.0 standard

- **JRFS-035Y**
with RM integrator (Rated current: 500 A / 333 mV)

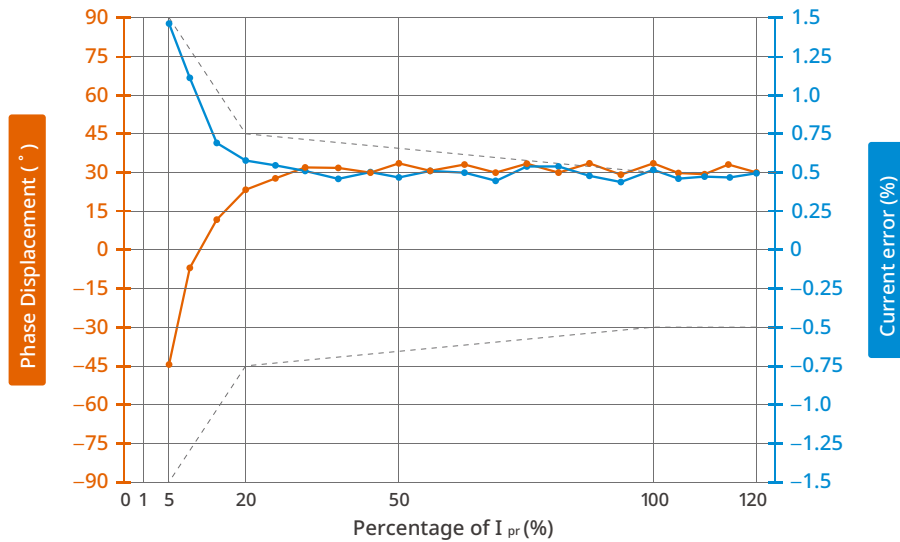

Only meets IEC 61869-2 Class 1.0 at rated currents greater than 500 A.

- **JRFS-055Y**
with RM integrator (Rated current: 1000 A / 333 mV)

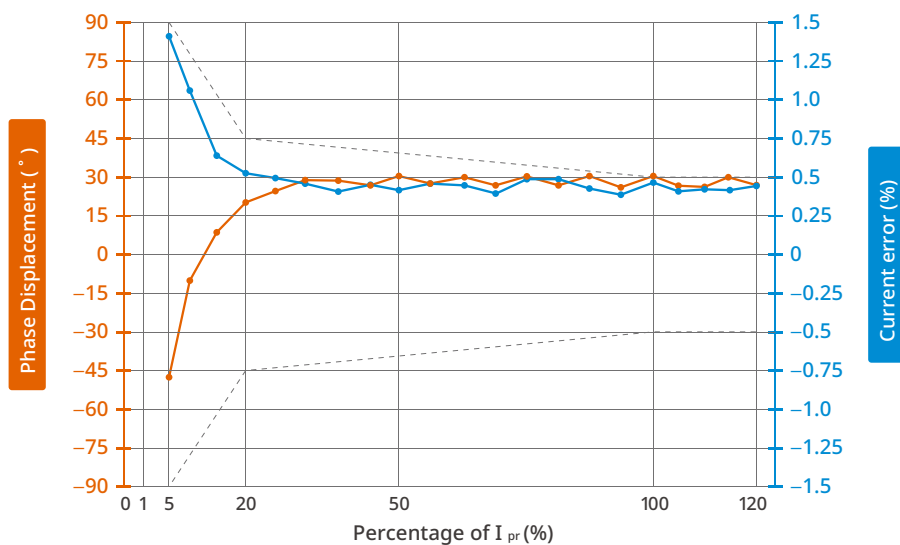

Only meets IEC 61869-2 Class 1.0 at rated currents greater than 1000 A.

- **JRFS-080Y**
with RM integrator (Rated current: 2000 A / 333 mV)

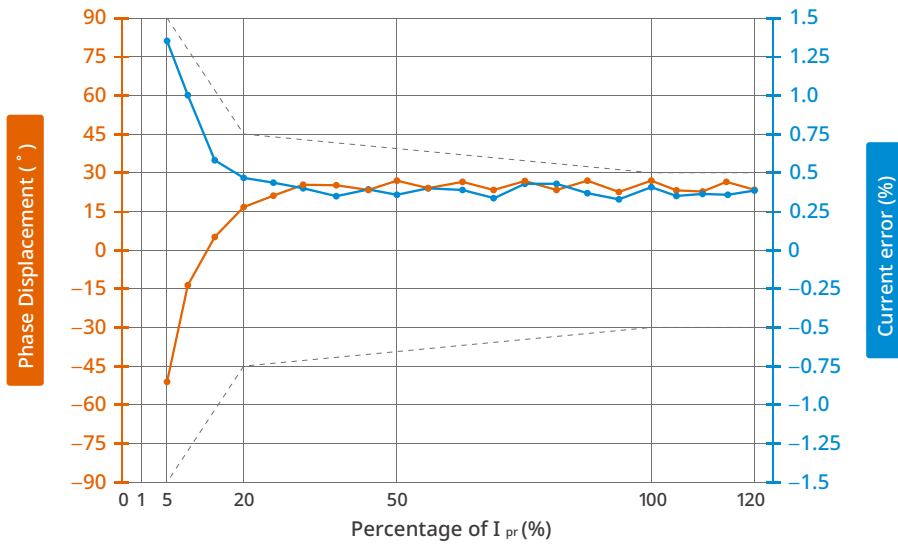

Only meets IEC 61869-2 Class 1.0 at rated currents greater than 2000 A.

- **JRFS-105Y**
with RM integrator (Rated current: 3000 A / 333 mV)

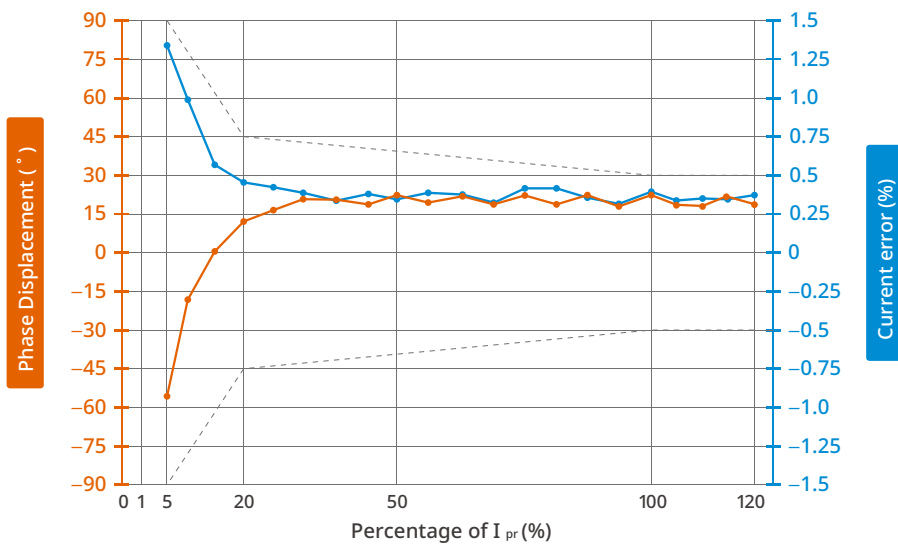

Only meets IEC 61869-2 Class 1.0 at rated currents greater than 3000 A.

5. Safety Notes

Caution : Danger

HAZARD OF ELECTRIC SHOCK, EXPLOSION, OR ARC FLASH

- In order to guarantee safe operation of the CT, please read and understand the instructions thoroughly. For your reference, see NFPA 70E in the USA, or applicable local codes. Safe operation can only be guaranteed if the Rogowski coil CT is used for the purpose as intended and designed within the limits of the technical specifications.
- Before servicing the CTs, turn off all sources of power and use a properly rated voltage sensing device to check if the power is off.
- The flexible Rogowski coil CT secondary must be shorted or connected to a burden all times. Certain parts of the module may carry hazardous live voltage (e.g. primary conductor).
- The flexible Rogowski coil CT must not be operated when it is not fully closed, or the installation is not completed.
- Do not apply around or remove from uninsulated hazardous live conductors which may result in electric shock, electric burn or arc flash.
- Rearrange all covers and protective devices before powering the equipment.
- A qualified person is the one who is skilled and has knowledge about the construction and operation of this electrical equipment, and has received safety training to recognize and avoid the hazards involved. (NEC 2011 Article 100)
- Ensure you have the latest technical information from the datasheet under www.hqsensing.com.

Notice

- Customizing output lead wire.
 - This product is not intentionally made for safety application.
 - Make sure not to install this flexible Rogowski coil CT in hazardous or classified areas.
 - The installer is responsible for conformance to all applicable codes. Safe and trouble-free operation of the flexible Rogowski coil CT can only be guaranteed if transport, storage, installation and maintenance are carried out correctly and with care.
 - Ignoring the warnings can lead to serious injury and/or cause damages.
 - If this product is used in a way not specified by the manufacturer, the protection offered by the product may be impaired.
- No responsibility is taken by J&D Smart Sensing for any consequences arising by not following this material properly.