

PRECISION CLAMP ON FLEXIBLE ROGOWSKI COIL CT

JRF MOI XXXXPU Series

CE RoHS2 COMPLIANT IP67 PROBE HEAD ONLY



JRF-MOI-PU Rogowski coil current transformer are accurate, flexible, rope style air coils that can be connected around conductors while the conductor is “lives”. They are easier to install and measure than traditional split and solid core CT. With their flexible design and light weight, they are ideal for bus bars and irregular-shaped bundles of multiple conductors. The Rogowski coil technology offers low phase shift error, inductance and excellent linearity while largely immune to electromagnetic interference and pulsed DC, providing a high rate of accuracy. JRF-MOI-PU coils can be used in single and three-phase measurement applications. The output of the built-in voltage integrator provides an AC voltage of 333mV at the rated input current. There is an option to choose a different output voltage between 100-500mV AC at up to 6,000 Amps. The built-in integrator and DC power supply allows simple wiring installation. Multiple rogowski coils can be powered by one AC/DC power supply.
 ※ Choose JRF-MOI-PUC if you require ties for fixing to the conductor

APPLICATIONS

- Revenue-Grade distribution transformer monitoring
- Energy sub-meters
- Power meters
- Power quality monitoring
- Condition monitoring
- Distributed measurement systems

FEATURES

- AC current probe
- Flexible and lightweight
- Easy & quick installation on uninterruptible power lines
- Insulation CATIII 1,000V AC, IV 600V AC.
- Accuracy Class 0.5/1.0 complying with IEC61869-2, ANSI C57.13
- In progress of certification for & CE complying with IEC61010-1
- IP65, IP67, IP68 (International Protection code)
- Several size are available from coil length from 285 to 385mm (aperture from 80 to 115 mm)

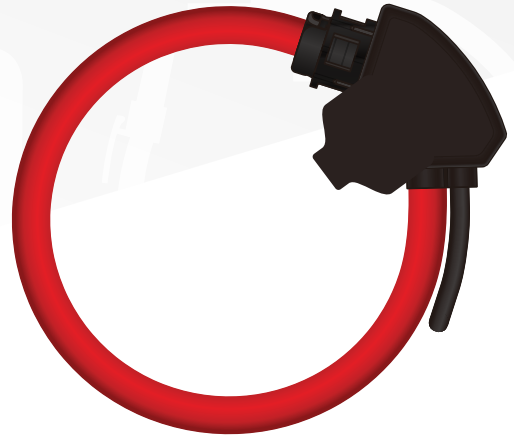

HOW TO USE



※ Please refer to “Flexible Rogowski Current Transformer Installation Guide” for further details.

SPECIFICATION

Model	JRF MOI XXXXPU-80	JRF MOI XXXXPU-115
Current Range	250 Amp to 6,000 Amp	
Rated Currents	250, 300, 400, 500, 600, 800, 1k, 1.2k, 1.5k, 2k, 2.4k, 2.5k, 3k, 4k, 5k, 6k	
Max Output	1.3VAC	
Accuracy	<1% typical at 2% to 120% of rated current	
Rated Output Voltage	333 mV AC	
Power Requirement	+24V DC, ±5%, 70mA Maximum	
Phase Shift	<0.5° at rated current	
Frequency	50/60Hz	
Linearity	±0.2%	
Conductor Position Sensitivity	±1% maximum	
Influence of External Fields	±1.5% maximum	
Operating Temperature Range	-25°C ~ +65°C	
Coil length	From 285 to 385mm	
Connection Cable Type	4 x AWG24	
Connection Cable length	on request	

OUTDOOR POWER & INDOOR POWER LOAD

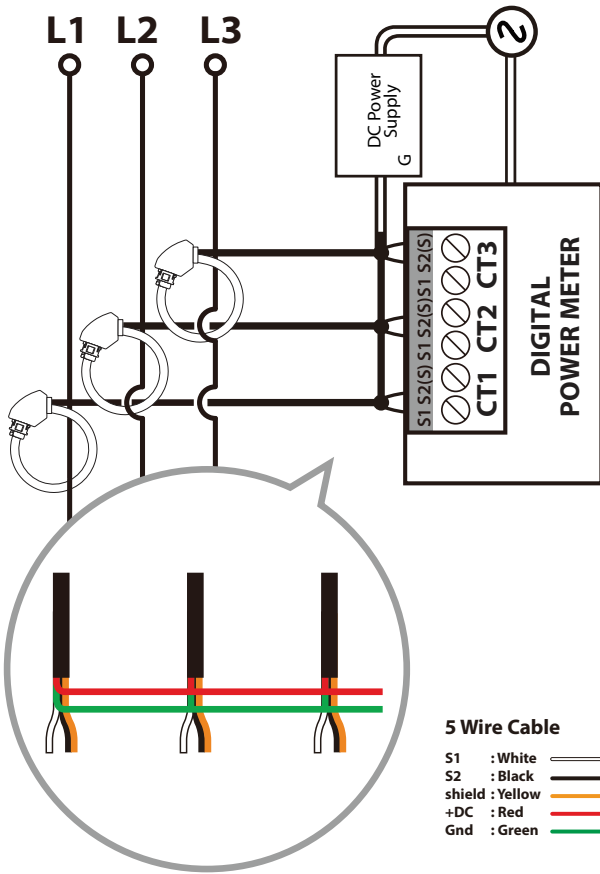

RATIO & PHASE ERROR GRAPH

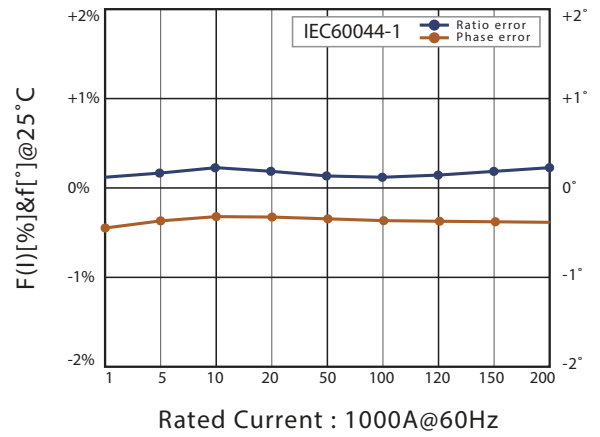

POSITIONING ERROR

Conductor Position	Typical Error(%)
● Adjacent to the coil edge	< 0.5%
● Adjacent to the clip together mechanism	< 0.5%
● Central in the Rogowski loop	0.1%

Note that with a larger conductor the variation of error with conductor position will decrease and approach the calibrated value.

AC/DC POWER SUPPLY

Models	Application	AC Input Voltage (Nominal)	Nominal Weight
FWA020012A-10B	Desktop power supply, For up to 24 pcs JRF-MOI xxxPU Conditioning Circuits	85-264 Vac (100-240)@1.67 amps	11.5 oz (326 grams)
MDR-10-12	DIN-rail power supply, For up to 12 pcs JRF-MOI xxxPU Conditioning Circuits	85-264 Vac (100-240)@0.84amps	6 oz (170 grams)

DIMENSIONS

(CHOOSE JRF-MOI-PUC IF YOU REQUIRE TIES FOR ATTACHING TO THE CONDUCTOR)

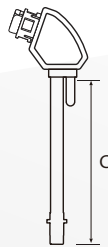
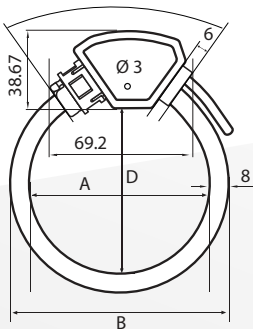

* Unit : mm

Model	A	B	C	D
JRF MOI xxxPU-80	80	96	285	80
JRF MOI xxxPU-115	115	131	385	115

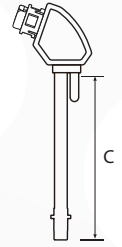
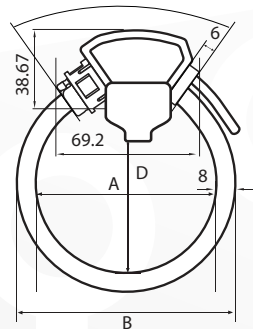

* Unit : mm

Model	A	B	C	D
JRF MOI xxxPUC-80	80	96	285	70
JRF MOI xxxPUC-115	115	131	385	105